

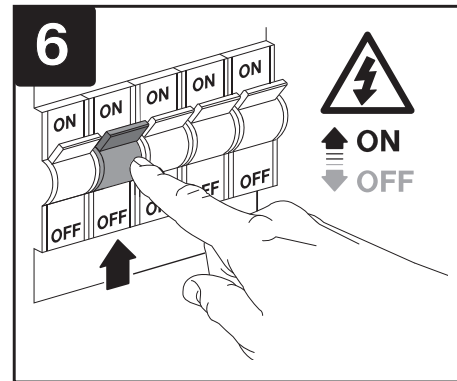

INSTALLATION MANUAL

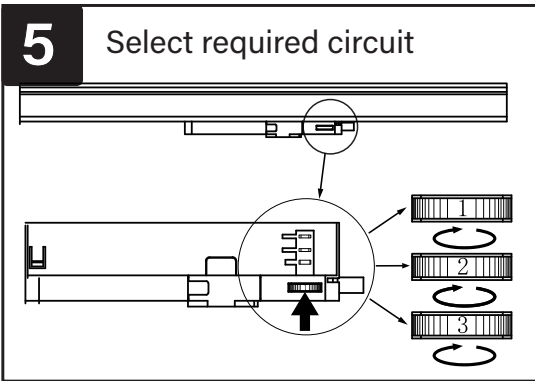

Remove fitting from track:

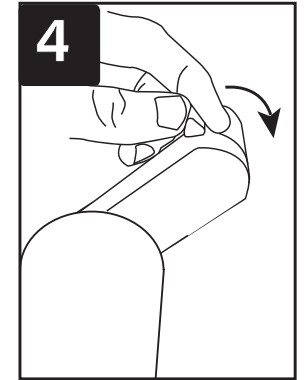
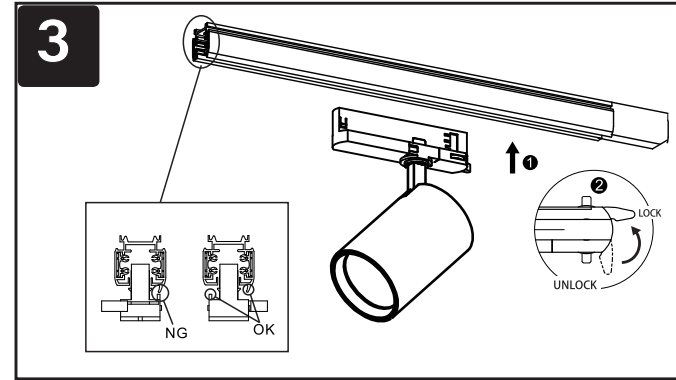
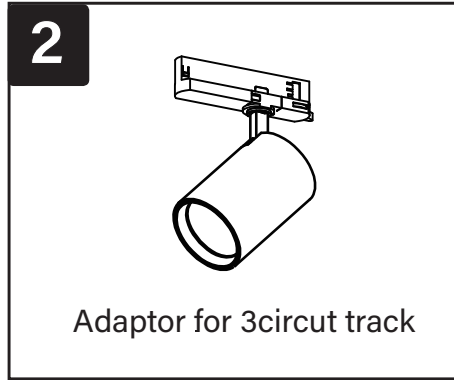
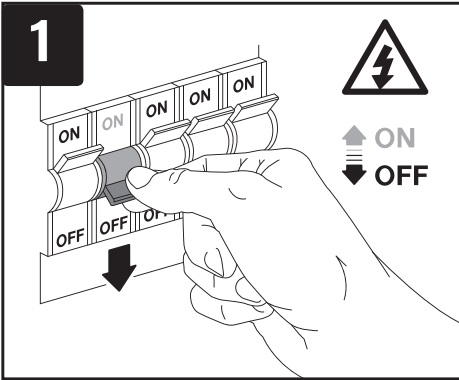
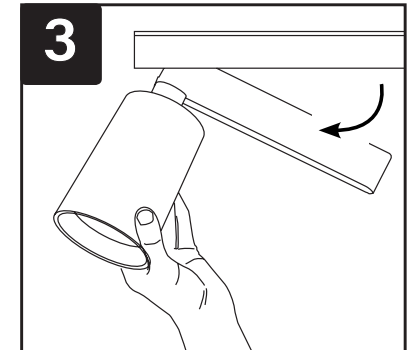
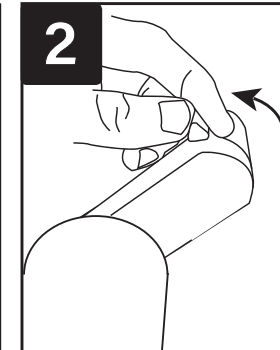
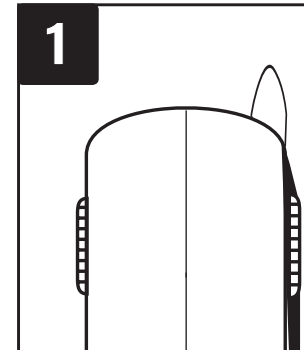

Warnings:

1. Make sure that the product is installed properly before connecting to electricity
2. Do not cover the fitting.
3. Maintenance and installation should only be carried out by a professional electrician

VLT529 RANGE

