

# Installation Instructions. Alto Street Light Code: 11700/1/2/3/4

Read these instructions before installation and retain for future reference

This equipment should be installed by a competent electrician



### Important Information

We recommend that luminaires are installed by a qualified electrician ensuring the installation complies with current IEE wiring regulations BS7671:2018 & local building control..

- BELL will not accept responsibility for any claims arising from a poor installation.
- IP66

This product may contain substances that can be hazardous to the environment if not disposed of properly. Electrical and electronic equipment should never be disposed of with general household waste but must be separated for its correct treatment and recovery.

Where possible recycle your packaging.

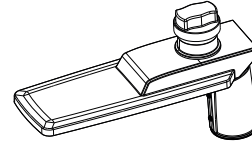
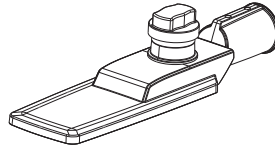

### Physical Dimensions(Unit: mm/inch)

30W/50W

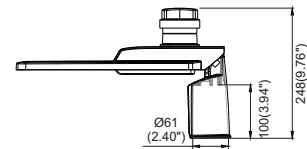
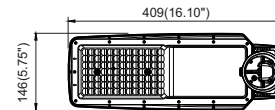
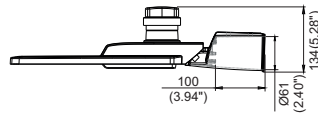
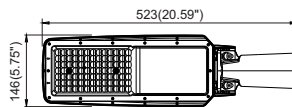

75W/100W

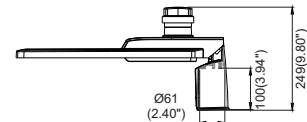
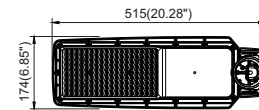
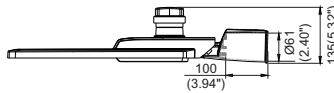
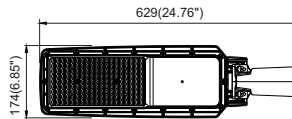

150W

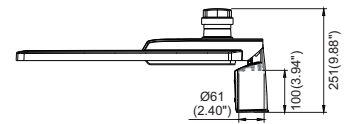
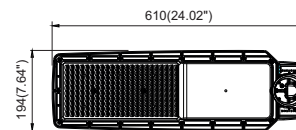
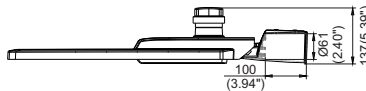
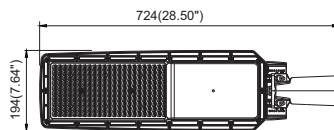

## Installation Instructions. Alto Street Light Code: 11700/1/2/3/4

Read these instructions before installation and retain for future reference

This equipment should be installed by a competent electrician



Specifications					
Power	30W	50W	75W	100W	150W
Input Voltage	220-240VAC				
Power Frequency	50 / 60 Hz				
Outlook Dimensions	Side entry mount	523x146x134mm(20.59"x5.75"x5.28")		629x174x135mm(24.76"x6.85"x5.32")	
	Post top mount	409x146x248mm(16.10"x5.75"x9.76")		515x174x249mm(20.28"x6.85"x9.80")	
Luminaire Net Weight	1.8±0.3kg(3.97±0.66Lbs)		3.2±0.3kg(7.05±0.66Lbs)		3.9±0.3kg(8.60±0.66Lbs)
Projected Area	0.06m <sup>2</sup> (0.75ft <sup>2</sup> )		0.09m <sup>2</sup> (1.13ft <sup>2</sup> )		0.12m <sup>2</sup> (1.5ft <sup>2</sup> )
Working Temperature	-30°C +35°C				
Storing Temperature	-40°C +70°C				

### Pole Mounting(30W~150W)

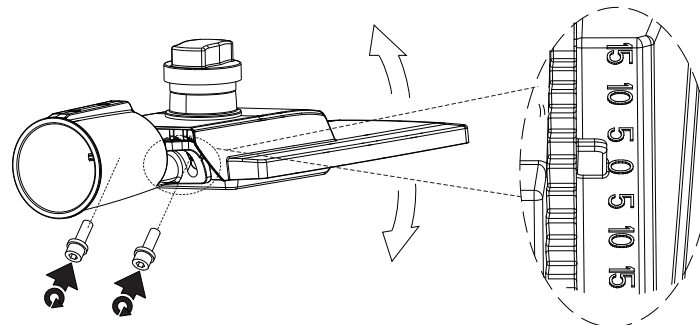
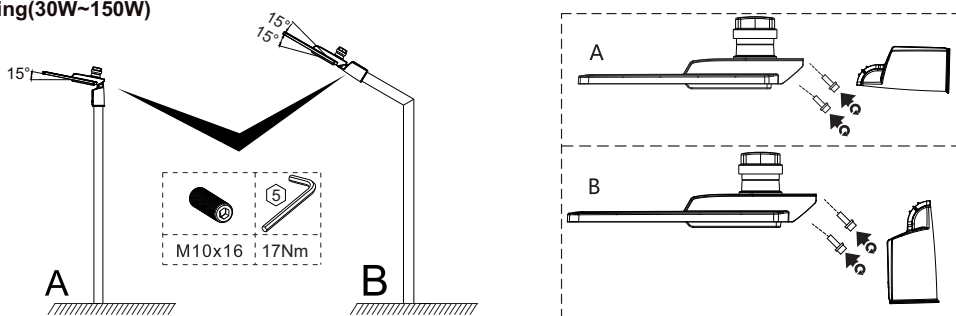

### Photocell(Optional)

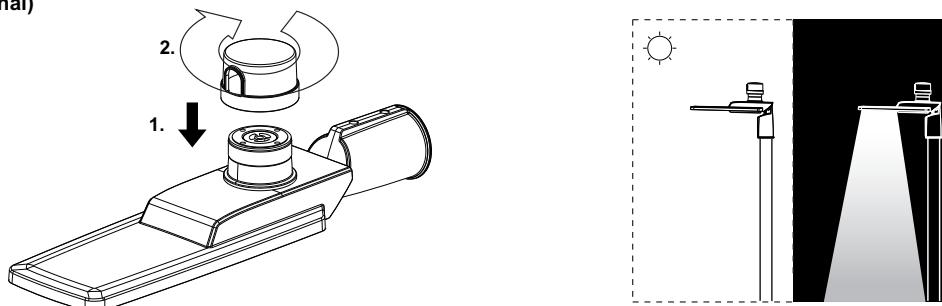

L	brown	black
N	blue	white
⊕ GND	yellow/green	green

- Please make sure the luminaire is properly earthed.
- The light source contained in this luminaire shall only be replaced by the manufacturer or his service agent or a similar qualified person. if the external flexible cable or cord of this luminaire is damaged, it shall be exclusively replaced by the manufacturer or his service agent or a similar qualified person in order to avoid a hazard.