

Commercial Gimbal LED Downlights

Installation instructions for LED commercial gimbal downlights



Warnings and cautions

- To avoid electric shock, serious injury or property damage, isolate power before installing, removing or servicing the product
- It is recommended that luminaires are installed by a qualified electrician and the installation complies with the local current wiring regulations.
- Any broken or damaged parts should be replaced as soon as possible. JCC will not accept responsibility for claims arising from sub-standard installations.
- It is recommended that the ambient room temperature should not exceed 25°C.
- This product is for indoor use only and should not be covered by any insulated material. 
- It may be necessary to upgrade your MCBs to allow for increased inrush current.
- Do not carry out insulation tests with the product connected to the circuit
- Standard product non-dimmable, add suffix "DIM" for DALI/1-10V dimmable version

INSTALLATION

ENGLISH

Code	Wattage	Colour Temperature	Beam angle	Lumens	LpcW
JC54303	35W	4000K	24°	3490	100
JC54304	35W	4000K	45°	3420	98
JC54305	35W	4000K	60°	3500	100

Figure 1.

Electrical connection

220-240V~ 50/60Hz / Class II 

LIVE = BROWN
NEUTRAL = BLUE

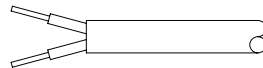

Double insulated- no earth required

Figure 2.

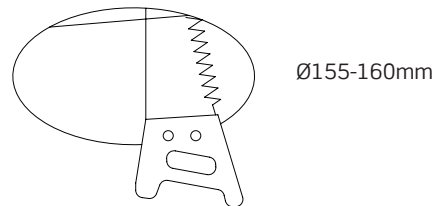

1. Cut the mounting hole in the ceiling, refer to Fig.2.
(JCC recommends that a sample hole is cut in a section of spare material to familiarize yourself with the process).
2. Ensure there is a minimum of 75mm space around the fitting. DO NOT COVER the fitting with insulation as indicated by this symbol  on the luminaire.
3. Connect the mains supply to the Luminaire driver as per Fig.1.
4. Connect required dimming control, see Fig.3.
5. Turn on the power supply to test the fitting. Once satisfied that the luminaire is functioning correctly, press the spring clips against the side of the luminaire and fit into the aperture.

Figure 3.



Profile & Dimensions

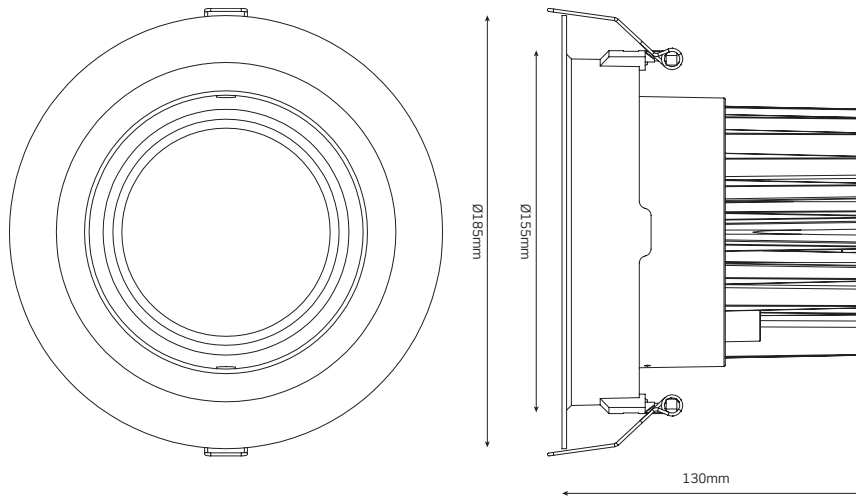

All dimensions in millimetres

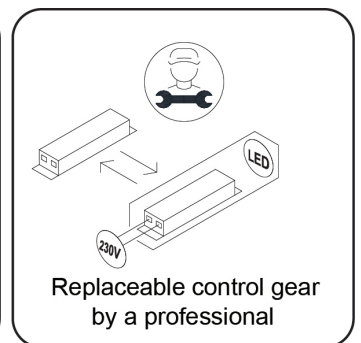
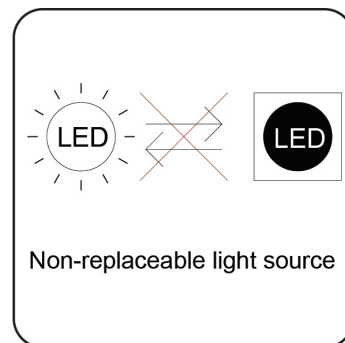

You can help protect the environment. Please remember to respect the local regulations: hand in the non-working electrical equipment to an appropriate waste disposal centre. The packaging material is recyclable. Dispose of the packaging in an environmentally friendly manner and make it available for the recyclable material collection service.

Important warranty information

This product is supported by a 2-year standard warranty which will extend to 5-years if registered within the first year of purchase. Please register at jcc.co.uk/warranty (Terms and conditions apply).

The installer will be asked to provide the following information, which is detailed on a label attached to the luminaire's chassis:
Product Code/Date Code.