

Installation Instruction

Product Code: JCEM110023WHDALI
JCEM110023BLKDALI

Product Description: EscapeLUX EM round surface spot downlight 2W 200lm 6K IP65
WH & BLK DALI

Specification

Function:	DALI 2
Dimension:	Ø155.5x46mm
Input Voltage:	AC220-240V 50/60Hz
Input Power:	Max 1.5W
Emergency Power:	1.3W
Lumen Output:	200lm
Battery:	LiFePO4 3.2V 3300mAh
Duration:	>3 hours
Classification:	Class II
IP Rating:	IP65

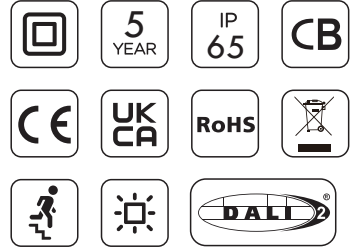

Routine Testing

Testing should be carried out in accordance with the recommendations of BS5266 & EN50172.

1. Do not switch off unswitched mains supply after installation. If interruption is unavoidable, the batteries must be disconnected or damage to the batteries may occur. Leave the luminaire on continuous charge for 24 hours.
2. Batteries should be replaced when the luminaire no longer meets the 3 hours duration performance.
3. Testing is performed by interrupting the unswitched supply for the test duration manually or self-test function complying with IEC62034. During testing the luminaire should remain illuminated in emergency mode.
4. Ensure that the 'charge indicator' is 'ON' during 'Charging Mode'. If the charge indicator (LED) is Unlit/red, this signifies a fault.
5. Replace faulty light source and batteries immediately.

Dimension

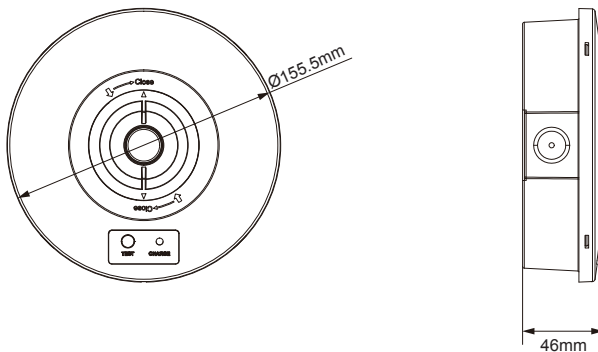

Installation Instruction

1

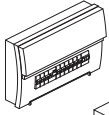

ALWAYS SWITCH OFF THE MAINS SUPPLY BEFORE INSTALLATION OR SERVICING

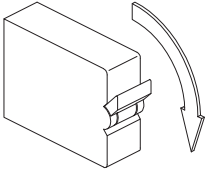

2

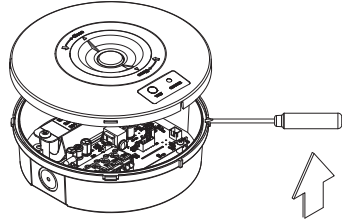

3

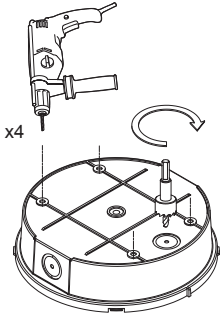

4

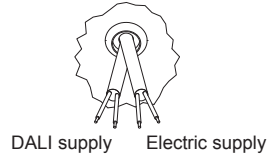
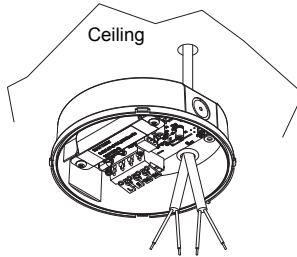

5

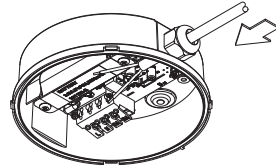
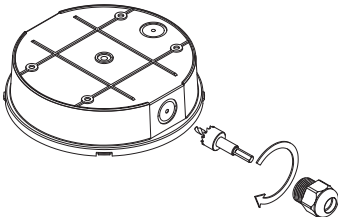

6

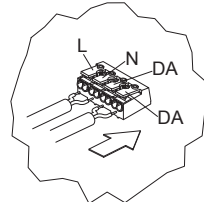
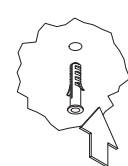
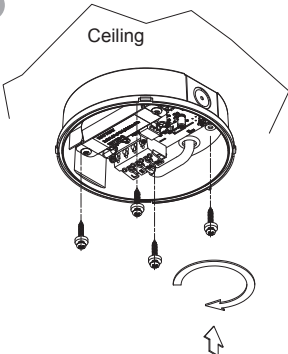

LUMINAIRE

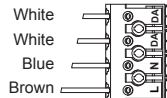

MAINS SUPPLY

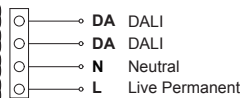

- | | | | |
|-------|---|----|----------------|
| White | → | DA | DALI |
| White | → | DA | DALI |
| Blue | → | N | Neutral |
| Brown | → | L | Live Permanent |

Installation Instruction

7

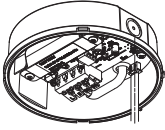

↑ Connect battery

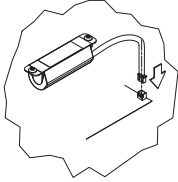

8

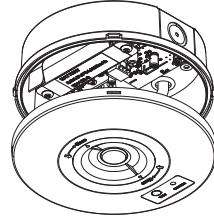

9

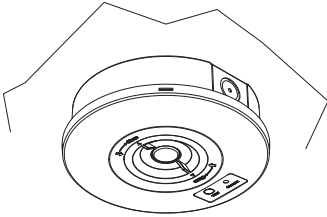

10

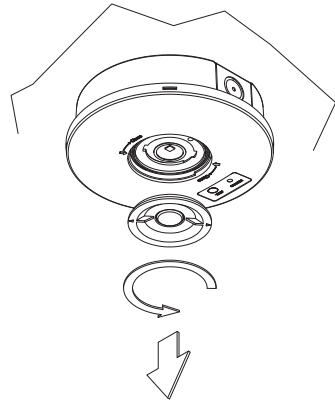

11

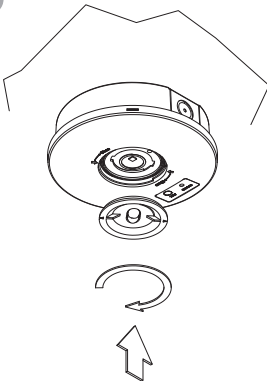

12

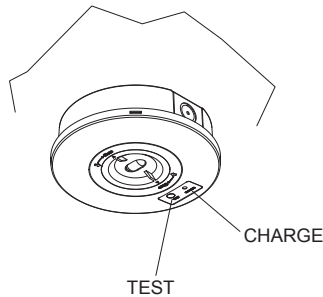

13

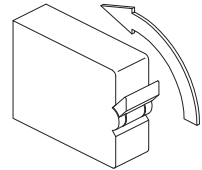

Battery replacement

LiFePO₄-26650-3300mAh-3.2V

1

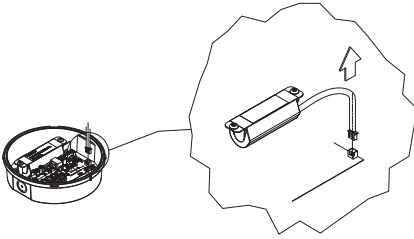

Disconnect the battery

2

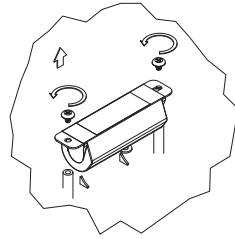

Remove the battery

3

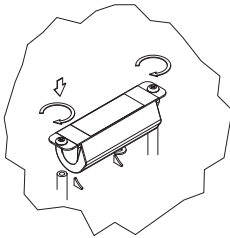

Replace the battery

4

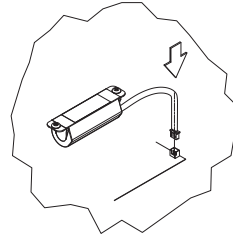

Connect the battery

Specifications for DALI Self-Test

Function Test

The time of day and frequency of the 5 second function test can be set by the DALI controller. The default setting is a 5 seconds test on a weekly basis (every 7 days). It will check the connection of battery, battery discharging and the connection of LED module.









Duration Test

The time of day and frequency of the duration test can be set by the DALI controller. The default setting is 3 hours test on a yearly basis (every 52 weeks). It will also check the connection of battery and LED module.

The unit will commence duration test after charging the batteries for 24 hours (initial charge). The 24 hours recharge occurs also if a new battery is connected.

Status Indication

System status is indicated by a bi-color LED indicator.

LED Colour	Status	On Time (Seconds)	Off Time (Seconds)	Description
Green	 Permanent on	/	/	Normal status when mains connected
	 Slow flash	1s	1s	Duration test underway
	 Fast flash	0.25s	0.25s	Function test underway
	 Double Pulse	2s	1s	Inhibit mode
Red	 Permanent on	/	/	LED failure/Open circuit/Short Circuit
	 Slow flash	1s	1s	Battery failure/Open circuit/Short Circuit
	 Double Pulse	2s	1s	Circuit failure/charging failure/other hardware failure
	 Fast Flash	0.25s	0.25s	Duration failure: capacity of the battery is not enough
Light Off	 Green & Red Off	/	/	Emergency mode/Mains not connected

A test switch is applied which can be used to:

Operation	Function
Press 200ms-1s	Initiate a 5S seconds function test
Press 3-10s	Initiate a duration test Note: This duration test can only be conducted when the battery is charged full. The duration test can be stopped by DALI controller if need.

Prolong Time

Prolong time can be set by the DALI controller. This is the delay time between return of the mains supply and the end of the emergency operation. The default prolong time is set as 0 minute. Indicator LED will stay off for the duration of the prolong time.

Timer Reset

Timer can be reset by DALI controller.

Rest Mode / Inhibit Mode

Emergency operations are automatically started when the mains supply is switched off. If the Rest Mode is activated, LED output will be switched off.

If the Inhibit Mode has been activated before the mains supply is switched off, Rest Mode will be automatically switched on if the mains supply is switched off within 15 minutes.

Rest Mode and Inhibit Mode can be initiated by the DALI controller. The REST command must be sent after the mains supply has been disconnected whilst the VADIS is in emergency operation. The inhibit command has to be sent while the VADIS is supplied by mains. After the mains reset, the VADIS exits the Rest Mode. Rest Mode and Inhibit Mode can both be disabled by sending the Terminate Inhibit/Rest mode command.