

# V50™ Pro Retrofit 135mm

Installation instructions for V50™ Pro Fire-rated Downlight Emergency



## Warnings and cautions

- To avoid electric shock, serious injury or property damage, isolate power before installing, removing or servicing the product
- It is recommended that luminaires are installed by a qualified electrician and the installation complies with the local current wiring regulations.
- Any broken or damaged parts should be replaced as soon as possible. JCC will not accept responsibility for claims arising from sub-standard installations.
- It is recommended that the ambient room temperature should not exceed 25°C.
- These products are designed for connection to a mains supply of 230-240V~ 50/60Hz
- It may be necessary to upgrade your MCBs to allow for increased inrush current.
- This Fire-rated downlight can be loosely covered with mineral wool insulation
- Do not carry out insulation tests with the product connected to the circuit
- For dimming guidelines please go to: [jcc.co.uk/dimming](http://jcc.co.uk/dimming)
- Maximum ceiling thickness 30mm

## INSTALLATION

ENGLISH

### Specification : V50™ Pro Fire-rated downlight EM

Colour Temperature: (WW)3000K\* / (CW)4000K (Switchable)

Ra: 80

Product	Wattage	Lumens	LpcW	IP
JC1015/WHEM	6W	650*/700lm	108/116	IP65 <sub>(front)</sub>

Maximum number of fittings on a circuit is not to exceed 20

Fig.1: Cut-out Diameter

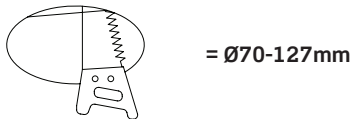

Fig.2 Electrical Input connections EM pack

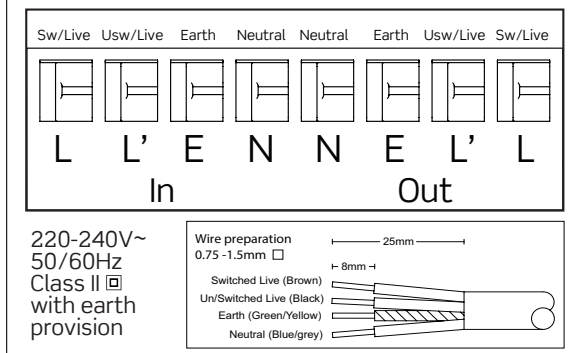
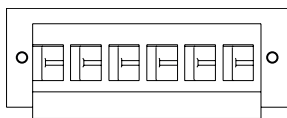

Fig.5: Driver Input Terminals



LENNEL

Fig.5.a: Loop in/Loop out connections

LV connection from Invertor to V50/V50 Pro Luminaire

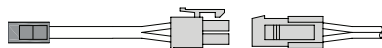

LV connection from V50/V50 Pro LED Driver to Invertor



Mains supply from Invertor to LED Driver

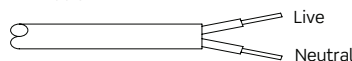

- Read the instructions and ensure that you have all of the tools and accessories required to complete the installation correctly.
- Isolate power supply before starting the installation.

### Installation instructions for V50™ Pro Emergency

- Cut the mounting hole in the ceiling; if you are unfamiliar with this process JCC recommends that a sample hole is cut in a section of spare material. See Fig.1.
- Once the mounting hole has been cut to the correct diameter connect remote pack to 220-240V~ supply (see Fig. 2).
- Make a 20mm Ø sized hole to install the LED charge indicator holder, adjacent to the luminaire to be installed and fit the indicator.
- At this stage it would be advisable to ensure that the correct CCT value has been selected for the application: the options are either Warm White or Cool White, and these can be altered by means of a small slider switch. (see Fig.4.) On the Standard version the switch is located behind the detachable 'twist-off' bezel and is under an integral cover, which maintains the IP65 rating. Replace the Bezel once you have selected your CCT option.

Fig. 4: CCT Switch

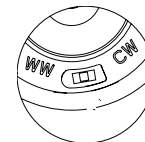

- Connect the luminaire to the remote pack (see Fig. 5 and Fig5.a). It is recommended that a light up test be carried out at this point. Once satisfied that the luminaire is fully functional press springs back against the body of the luminaire and push luminaire body into aperture. Please note: All mains supply wiring must be connected to the Emergency Remote pack as per Fig.2. Please allow a full 24 Hours charge is carried out prior to testing.

### LED Indicator Guide

Green light on: charging/normal operation  
No indicator light on: indicates fault

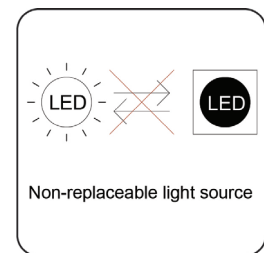
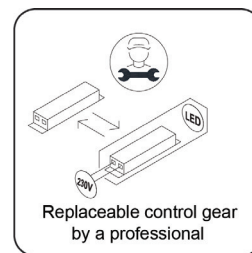

You can help protect the environment. Please remember to respect the local regulations: hand in the non-working electrical equipment to an appropriate waste disposal centre. The packaging material is recyclable. Dispose of the packaging in an environmentally friendly manner and make it available for the recyclable material collection service.

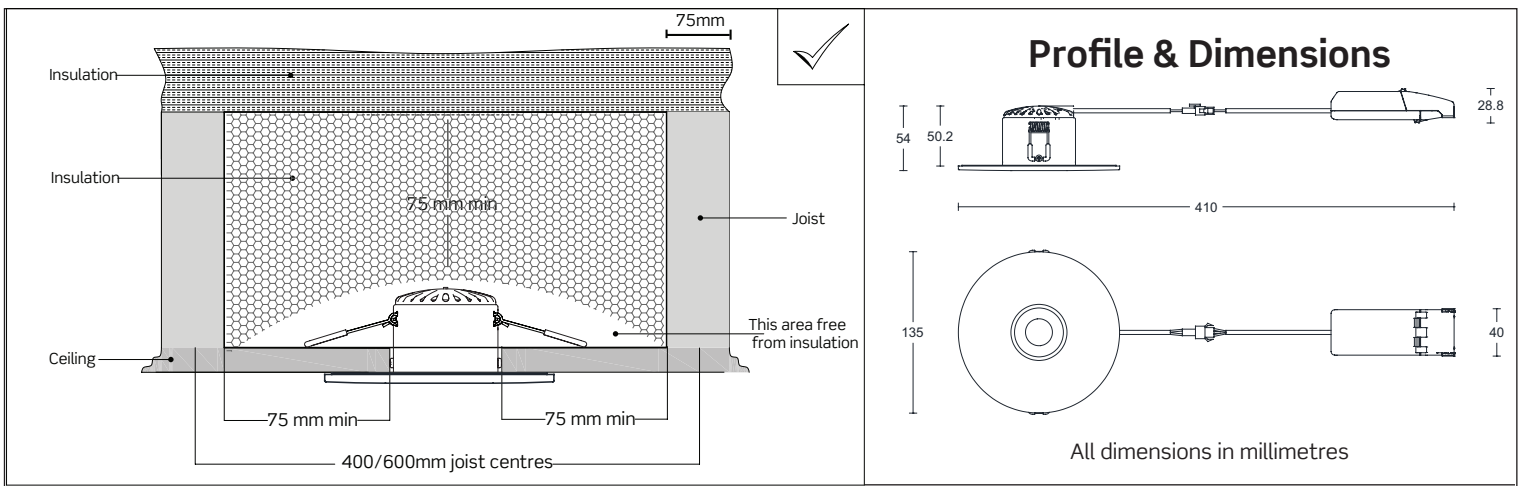

**Complies with:**

Part B Fire Safety, Part C Resistance to Contaminants and Moisture, Part E Resistance to Sound, Part L Conservation of Fuel and Power

**Emergency range routine inspection and test**

All tests must be undertaken at times of least risk and in accordance with EN 50172:2004 as indicated below:

Daily: Indicators of central power supply shall be visually inspected for correct operation.

Monthly: (in addition to the daily check) If automatic testing devices are used, the results of the short duration tests shall be recorded. Test shall be carried out as follows:

- a) Switch the luminaire over to emergency mode to operate from the batteries by simulating a failure of supply to the normal lighting for a period sufficient to ensure correct luminaire operation

NOTE: The period of simulation failure should be sufficient for the purpose of this clause whilst minimising damage to the system components e.g lamps. During this period, all luminaires and signs shall be checked to ensure that they are present, clean and functioning correctly. At the end of this test period, the supply to the normal lighting should be restored and any indicator lamp or device should be checked to ensure that it is showing that the normal supply has been restored.

Annually: If automatic testing devices are used, the results of the short duration tests shall be recorded. For all other systems the monthly inspection shall be carried out and the following additional tests made:

- a) Each luminaire and internally illuminated sign shall be tested monthly as above but for its full duration in accordance with the manufacturer's information.
- b) The normal supply for the luminaire should be restored and any charge indicator lamp or device should be checked to ensure that it shows the normal supply has been restored. The charging arrangements should be checked for proper functioning.
- c) The date of the test and its results shall be recorded in the system logbook.

A copy of this report must accompany any fitting returned to the manufacturer for any reason.

Month	Test Type	First Year		Second Year		Third Year		Fourth Year		Fifth Year	
		Sign	Date	Sign	Date	Sign	Date	Sign	Date	Sign	Date
January	Functional										
February	Functional										
March	Functional										
April	Functional										
May	Functional										
June	Functional										
July	Functional										
August	Functional										
September	Functional										
October	Functional										
November	Functional										
December	3 hour										

**Important warranty information**

This product is supported by a 2-year standard warranty which will extend to 3 years for commercial applications and 5 years for domestic applications if registered within the first year of purchase. Please register at [jcc.co.uk/warranty](http://jcc.co.uk/warranty) (Terms and conditions apply).

The installer will be asked to provide the following information, which is detailed on a label attached to the luminaire's chassis: Product Code/Date Code.