

TIMEGUARD®

7 Day Digital Programmer 3 Channel – Surface Mount

Model: TRT038N



Installation & Operating Instructions

1. General Information

These instructions should be read carefully and retained for further reference and maintenance.

2. Safety

- Before installation or maintenance, ensure the mains supply to the programmer is switched off and the circuit supply fuses are removed or the circuit breaker turned off.
- It is recommended that a qualified electrician is consulted or used for the installation of this programmer and install in accordance with the current IEE wiring and Building Regulations.
- Check that the total load on the circuit including when this programmer is fitted does not exceed the rating of the circuit cable, fuse or circuit breaker.
- To clean use a clean dry cloth only. Do not use any liquid cleaners.

3. Technical Specifications

- 230V AC 50 Hz
- This programmer is of Class II Construction and must not be earthed
- Switch Rating: 3(1)A
- Switch Type: Single pole, double throw (SPDT) for heating zones and hot water, voltage free contacts
- Connection Type: 3 wire
- Installation Type: Surface mount with wall plate
- Micro Disconnection: Type 1.B control action
- Operating Temperature Range: 0°C to +40°C
- Time Control Periods: 3 per day
- Clock Format: 12hr AM/PM or 24hr
- Summer/Winter Changeover: Day light saving, GMT or BST
- Holiday Mode: 0 to 31 day programme suspension
- Boost Function: 1 or 2 hour for heating zones and hot water

- Battery Backup: 7 day, factory fitted rechargeable (non-replaceable)
- Illumination: Blue LED illuminated on setting for button surrounds and display
- CE Compliant
- Dimensions (H x W x D): 90 x 135 x 30mm

TRT038N Front View

Output LED's for channel switch status

Advance button to next programme

1 and 2 hour boost for central heating zones and hot water (illuminates on setting)

12hr am/pm or 24hr clock timer display (illuminated on setting)

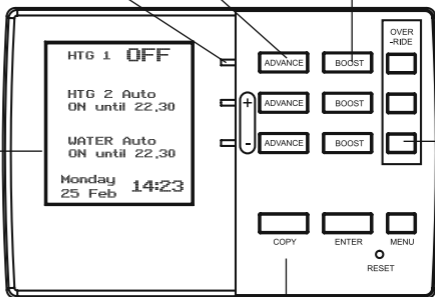

Flip down cover conceals setting buttons

Programme override for each channel

4. Siting

- The TRT038N should be located at a position which eases wiring runs and gives good access for programming.
- It should be mounted approximately 1.5m above floor level.

5. Installation

- 5.1 Ensure the mains supply is switched off and the circuit supply fuses are removed or the circuit breaker turned off.
- 5.2 Remove the wall plate from the unit, by undoing the retaining screws, and pivoting the bottom of the unit outwards. The TRT038N body can then be lifted off.
- 5.3 Mark the position of the mounting holes on the wall using the wall plate as a template. Drill out the mounting holes taking care to avoid any joists, electrical cables or water/gas pipes that may be hidden beneath the surface. Insert the rawl plugs into the holes.
- 5.4 Pass the 230V 50Hz mains supply and load cables through the opening of the wall plate. Allow sufficient excess cable to wire up the unit, but not too much to make it difficult to close the unit to the wall plate.
- 5.5 Fix the wall plate to the wall using the correct mounting screws for the rawl plugs installed. The retaining screws which secure the unit to the wall plate should be at the bottom.
- 5.6 Terminate the cables into the terminal block ensuring correct polarity is observed and that all bare conductors are sleeved (See section 6. Connection Diagram). Make sure that the curved washer grips the conductor.
- 5.7 To reinstall the unit onto the wall plate, first ensure the wall plate retaining screws are loosened enough to clear the TRT038N body, then engage the top of the TRT038N onto the wall plate retaining tabs, and push firmly downwards and then upwards. There will be some resistance from the terminals.
- 5.8 Once in place, secure with the retaining screws making sure not to over tighten.

TRT038N Wall Plate

Alternate mounting holes

Retaining tabs

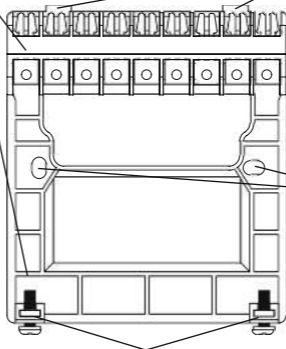

Mounting holes

Wall plate retaining screws

6. Connection Diagram

Connect the 230V 50Hz mains supply and load cables to the terminal block which are marked as follows;

- Note: Check boiler instructions before connecting.

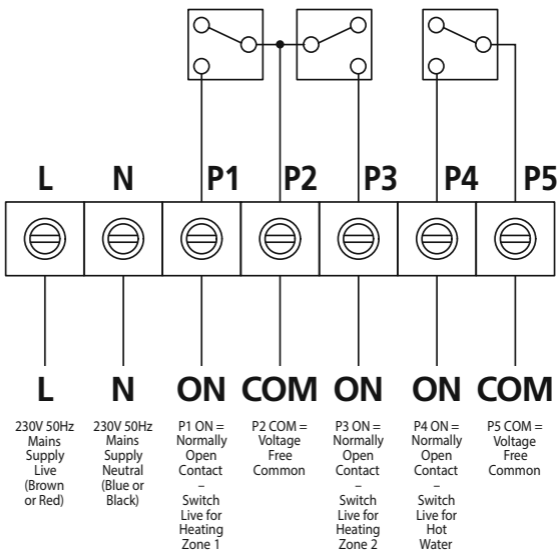

7. Reset from Power-up

- 7.1 Restore mains to the unit after making sure to check all system wiring is complete.
- 7.2 Press the reset button located beneath the flip down cover on the front of the unit, the screen will fade and then reappear showing all available channels as well as the default time and date at the bottom of the display.
- 7.3 There are 3 time controlled periods per day, and the default programmes are as follows;

M, T, W, Th, F = PERIOD 1 ON 06:30 OFF 08:30
PERIOD 2 ON 12:30 OFF 12:30
PERIOD 3 ON 17:00 OFF 22:00
Sa, Su = PERIOD 1 ON 08:00 OFF 10:00
PERIOD 2 ON 12:30 OFF 13:30
PERIOD 3 ON 17:00 OFF 23:00

8. Setting the Time and Date

- 8.1 To set up the time and date, press the menu button. Then navigate to the settings option using the advance buttons marked beside the + and – indicators. Press enter to select settings.

SETTINGS.

PRESS MENU  AND THEN  AND ENTER TO SELECT SETTINGS. 

- 8.2 On the settings menu, the time and date option will be highlighted. Press enter to begin setting the time and date.

SETTINGS

TIME AND DATE
DAYLIGHT SAVING
CLOCK OPTIONS
HEADINGS

- 8.3 The hour will be highlighted on the display. Use the advance buttons marked beside the + and – indicators to alter the hour. Press enter once to confirm.

14:15
1 DEC 2016

TIME AND DATE
14:15
1 DEC 2016

- 8.4 The minutes will now be highlighted on the display. Use the advance buttons marked bedside the + and – indicators to alter the minutes. Press enter once to confirm.

14:15
1 DEC 2016

TIME AND DATE
14:15
1 DEC 2016

- 8.5 The day of the month will now be highlighted on the display. Use the advance buttons marked bedside the + and – indicators to alter the day of the month. Press enter once to confirm.

14:15
1 DEC 2016

TIME AND DATE
14:15
1 DEC 2016

- 8.6 The month will now be highlighted on the display. Use the advance buttons marked beside the + and – indicators to alter the month. Press enter once to confirm.

14:15
1 DEC 2016

TIME AND DATE
14:15
1 DEC 2016

- 8.7 The year will now be highlighted on the display. Use the advance buttons marked beside the + and – indicators to alter the year. Press enter once to confirm.

- 8.8 Press the menu button twice to exit to the settings menu.

Daylight Saving

- 8.9 Automatic summer/winter times (BST+1/BST) can be selected or deselected. It is on by default.
- 8.10 Select the daylight savings option from the settings menu. Set this value either ON or OFF using the advance buttons marked beside the + and – indicators. When complete press the menu button to exit to the settings menu.



Clock Options

- 8.11 12 hour or 24 hour clock formats can be selected. The default value is the 24 hour format.
- 8.12 Select clock options from the settings menu. Set this value to either 24 hour or AM/PM using the advance buttons marked beside the + and – indicators. When complete, press the menu button to exit to the settings menu.

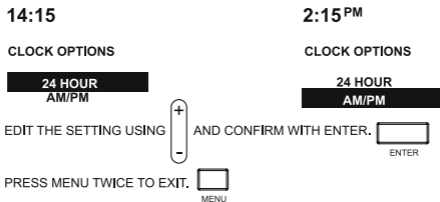

9. Programme Preparation (Headings)

- 9.1 Decide which heading suits best for the channels to be displayed. They can be set as channels being channel 1, 2 and 3, split as heating and hot water being heating 1, heating 2 and water as the third channel. Zones can be applied to each channel as a heading being zone 1, 2 and 3.
- 9.2 To implement this setting, press the menu button and select the settings menu using the advance buttons marked beside the + and – indicators. Press enter to confirm.
- 9.3 Once in the settings menu, select the headings option using the advance buttons marked beside the + and – indicators and press enter.
- 9.4 Select the heading required using the advance buttons marked beside the + and – indicators and press enter to confirm.

HEADINGS

HEATING/WATER

ZONES

CHANNELS

EDIT THE SETTING USING  AND CONFIRM WITH ENTER.

PRESS MENU TWICE TO EXIT.

HTG 1 Auto
OFF until 17:00

HTG 2 Auto
OFF until 17:00

WATER Auto
OFF until 17:00

Thursday
1 Dec **09:36**

ZONE 1 Auto
OFF until 17:00

ZONE 2 Auto
OFF until 17:00

ZONE 3 Auto
OFF until 17:00

Thursday
1 Dec **09:36**

CHAN 1 Auto
OFF until 17:00

CHAN 2 Auto
OFF until 17:00

CHAN 3 Auto
OFF until 17:00

Thursday
1 Dec **09:36**

HEATING/WATER

ZONES

CHANNELS

DEFAULT IS CHANNELS.

- 9.5 Once the heading is set, press the menu button until the main screen has been reached.

10. Programme Entry

Please read the following notes on programming before proceeding.

- PROGRAMMES FOR DIFFERENT CHANNELS ARE ENTERED AND CAN BE EDITED SEPARATELY.
- TIMES CAN ONLY BE SET IN 10 MINUTE INCREMENTS.
- THE COPY FUNCTION CAN BE USED TO DUPLICATE ON AND OFF TIMES FOR DIFFERENT DAYS OF THE WEEK, AS DETAILED FURTHER IN THE INSTRUCTIONS (READ IN FULL BEFORE YOU BEGIN).
- PROGRAMME ENTRY TIMES OUT AFTER 60 SECONDS, OR PRESS SET 3 TIMES.

10.1 Press menu and then enter to set channel 1, the advance buttons marked beside the + or – indicators can be used to select an alternative channel, zone etc. if required.

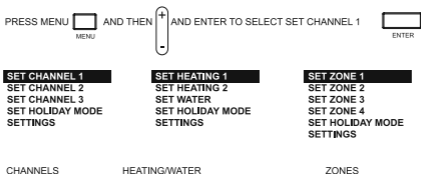

10.2 The on time will be highlighted for period 1. Use the advance buttons marked beside the + or – indicators to increase or decrease the value of the ON time by 10 minute increments. Once the ON time has been set press enter.

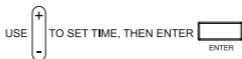

24 HOUR OR AM/PM ACCORDING TO SETTINGS.

- 10.3 The OFF time will be highlighted for period 1. Use the advance buttons marked beside the + or – indicators to increase or decrease the value of the OFF time by 10 minute increments. Once the OFF time has been set press enter.

SET CHANNEL 1
THURSDAY

Period 1

On6:30AM Off8:30AM

Period 2

ON12:30PM Off12:30PM

Period 3

ON5:00PM Off10:00PM

USE  TO SET TIME, THEN ENTER ENTER

24 HOUR OR AM/PM ACCORDING TO SETTINGS.

SET TIMES FOR ALL PERIODS USING  AND ENTER. ENTER

- 10.4 The on time will be highlighted for period 2. Follow steps '10.2 to 10.3' for (Period 2 ON and OFF) and also (Period 3 ON and OFF).

- 10.5 When Period 3 OFF has been set and enter has been pressed the unit will automatically move to the next day of the week to programme (Friday for example).

SET CHANNEL 1
FOR

FRIDAY

PRESS ENTER TO EDIT FRIDAY, OR COPY TO COPY THE DAY TO A DIFFERENT DAY. ENTER COPY

PRESS MENU TWICE TO EXIT. MENU

- 10.6 To enter or edit programs, press enter and follow steps '10.2 to 10.3' for each day required and press menu to return to the main screen when complete.

Note:

- All 3 time controlled periods will need to be programmed, unwanted time periods need to be entered as the same time i.e. Period 2 ON 7:00AM, Period 2 OFF 7:00AM, Period 3 ON 7:00AM, Period 3 OFF 7:00AM.
- Unwanted days of the week will also need to be entered as the same time.

Copy Mode (Brief Explanation)

See Program Modes for a full breakdown.

(IMPORTANT Copy Mode can only be used directly after programming at least one day)

- 10.7 To copy the settings from a different day to Friday, select a day that has already been programmed (Thursday for example) via the advance buttons marked with the + or – indicators and press the copy button.

- 10.8 The periods for the day being copied will be shown on the display briefly. The next day of the week will be on the display (Friday for example), press the copy button again to copy the period settings from Thursday to Friday. If a different day is required to apply the copied settings, use the advance buttons marked with the + or – indicators to select an alternative day and press the copy button. Press menu to return to the main screen when complete.

11. Operation

Programme Modes

Copy Function

Note that the images used for the COPY function are for guidance only and may not represent the users situation directly.

- 11.1 Copy mode can only be used directly after programming at least one day. Press the copy button to copy the day that has just been programmed.

USING COPY:

AFTER PROGRAMMING ONE DAY, SAY MONDAY, PRESS ENTER AFTER PROGRAMMING PERIOD 3 OFF. THE SCREEN THEN SHOWS:

SET CHANNEL 1
FOR

TUESDAY

- 11.2 Press copy, and the programme from the original day copied will be applied to the next subsequent day. The programmes used from the original day copied will be displayed on screen for the following day.

PRESS COPY, AND THE PROGRAM FROM MONDAY IS COPIED TO TUESDAY: THE SCREEN BRIEFLY SHOWS:

SET CHANNEL 1
TUESDAY

Period 1

ON6:30AM Off8:30AM

Period 2

ON12:30PM Off12:30PM

Period 3

ON5:00PM Off10:00PM

- 11.3 The next subsequent day will be displayed; again the copy button can be used to apply the settings to this day. If an alternative day is required, used the advance buttons marked beside the + or – indicators to select an alternative day of the week and then press copy to apply the settings from the day originally copied.

AFTER WHICH THE SCREEN SHOWS:

SET CHANNEL 1
FOR

WEDNESDAY

PRESS COPY AGAIN, AND THE PROGRAM FROM MONDAY IS COPIED TO WEDNESDAY:
DAYS CAN BE MISSED USING



AND THEN COPY ONCE THE CORRECT DAY IS SHOWN.



IF ENTER IS PRESSED, THE DISPLAYED DAY CAN BE EDITED



- 11.4 If 5+2 programming is required (for example Mon-Fri as a set and Sat-Sun as a set) enter programmes for Monday and copy the programmes until Friday. When Saturday is displayed on screen press enter to set the alternative weekend times and then press copy to apply those times to Sunday.

EXAMPLE OF 5 PLUS 2 PROGRAMMING:

MONDAY



TUESDAY



WEDNESDAY



THURSDAY



FRIDAY



SATURDAY



SUNDAY



PRESS MENU ONCE TO RETURN TO SELECTING CHANNEL, OR TWICE TO EXIT.



Boost Function

- 11.5 Pressing the boost button from the OFF position will give a 1 hour boost. A second press will give a two hour boost; pressing the boost button a third time will cancel the boost operation.

BOOST:

BOOST FROM OFF GIVES 1 HOUR BOOST, THEN 2 HOUR BOOST, THEN CANCELS
SCREEN SHOWS:

CHAN 3 OFF until	Auto 17:00	CHAN 3 ON until	Auto 10:40	CHAN 3 ON until	Auto 11:40	CHAN 3 OFF until	Auto 17:00
Thursday 1 Dec	09:36	Thursday 1 Dec	09:36	Thursday 1 Dec	09:36	Thursday 1 Dec	09:36
BOOST CHAN 4		FIRST PRESS		SECOND PRESS		THIRD PRESS	

- 11.6 Pressing the boost button from the ON position adds a 1 hour boost. A second press will add a 2 hour boost to the next off time. Pressing the boost button a third time will cancel the boost operation.
- 11.7 The boost option can be set independently for all channels using the separate boost buttons. During any boost period the boost button will remain illuminated.

Advance

- 11.8 Pressing the advance button, changes the output status until the next programmed change, e.g. if a programme is due to switch ON at 17:00 and OFF at 22:00 the advance button can be pressed to switch ON the output ahead of time. Therefore the programme would run from when the advance button is pressed until the next programmed off time (22:00).

ADVANCE:

ADVANCE CHANGES THE OUTPUT STATUS UNTIL THE NEXT PROGRAMMED CHANGE

CHAN 3 OFF until	Auto 17:00	CHAN 3 ON until	Auto 22:00
Thursday 1 Dec	09:36	Thursday 1 Dec	09:36

- 11.9 The advance button can also be used for the opposite, e.g. if a programme is due to switch OFF at 22:00, pressing the advance button would switch OFF the programme ahead of time. This would result in the unit displaying the next programme ON time which in this case would be 06:00.

CHAN 3 ON until	Auto 22:00	CHAN 3 OF until	Auto 06:00
Thursday 1 Dec	18:36	Thursday 1 Dec	18:36

DURING ADVANCE THE ADVANCE BUTTON REMAINS ILLUMINATED UNTIL NEXT PROGRAM CHANGE
CANCELLING ADVANCE RETURNS TO THE PROGRAMMED TIMES.

Over-Ride

- 11.10 Over-Ride includes 4 different functions, all day, ON, OFF and AUTO. Each function can be selected by pressing the over-ride button assigned to the channel you require to override.
- 11.11 If set to all day, the output will be switched ON from the first ON time until the third programme OFF time scheduled for that day has been reached for the selected channel.
- 11.12 If set to ON, the output will be switched ON permanently for that channel.
- 11.13 If set to OFF, the output will be switched OFF permanently for that channel.
- 11.14 If set to AUTO, programmed periods will run as normal as they have been set to for the current day.

OVER-RIDE:

OVER-RIDE HAS 4 FUNCTIONS, ALL DAY, ON, OFF AND RETURN TO AUTO MODE.

ALLDAY:	ON:	OFF:	AUTO:
CHAN 3 ON until	CHAN 3 ON	CHAN 3 OFF	CHAN 3 OFF until
Thursday 1 Dec	Thursday 1 Dec	Thursday 1 Dec	Thursday 1 Dec
All day 22:00	09:36	09:36	Auto 17:00
09:36		09:36	09:36

ALLDAY STARTS FROM THE FIRST ON TIME, AND ENDS AT THE 3RD OFF TIME
ON IS PERMANENTLY ON UNTIL OVER-RIDE IS CANCELLED
OFF IS PERMANENTLY OFF UNTIL OVER-RIDE IS CANCELLED.







Holiday Mode

- 11.15 Holiday mode suspends all programmes from mid-day of the start date and will reinstate the programmes mid-day of the return date. To enable this mode press the menu button, then use the advance buttons marked beside the + or – indicators to select 'set holiday mode' and press enter to confirm. See below for holiday setting instructions.

HOLIDAY:

HOLIDAY SUSPENDS ALL PROGRAMMES FROM MID DAY ON THE START DATE UNTIL MID DAY ON THE RETURN DATE. ACCESSIBLE THROUGH MENU, SET HOLIDAY MODE: THEN USE TO SELECT OPTION, AND ENTER TO CONFIRM.

SET CHANNEL 1	SET HOLIDAY MODE	SET HOLIDAY MODE	
SET CHANNEL 2			THURSDAY
SET CHANNEL 3	START AT MID-DAY	START AT MID-DAY	01 DEC 2017
SET HOLIDAY MODE	ON: 25 NOV 2017	ON: 01 DEC 2017	TO MONDAY
SETTINGS	FINISH AT MID-DAY	FINISH AT MID-DAY	05 DEC 2017
	ON 25 NOV 2017	ON 05 DEC 2017	
CHANGE DATES USING  AND ENTER <input type="text"/> THEN PRESS MENU 2 X TO EXIT. <input type="text"/>	<input type="text"/>	<input type="text"/>	<input type="text"/>
	ENTER		MENU

DEFAULT DATES FOR HOLIDAY ARE THE PRESENT DAY.
SET START AND FINISH DATES TO THE SAME TO CANCEL

3 Year Guarantee

In the unlikely event of this product becoming faulty due to defective material or manufacture within 3 years of the date of purchase, please return it to your supplier in the first year with proof of purchase and it will be replaced free of charge. For the second and third years or any difficulty in the first year telephone the helpline on 020 8450 0515.

Note: A proof of purchase is required in all cases. For all eligible replacements (where agreed by Timeguard) the customer is responsible for all shipping/postage charges outside of the UK. All shipping costs are to be paid in advance before a replacement is sent out.



If you experience problems, do not immediately
return the unit to the store.
Telephone the Timeguard Customer Helpline;

HELPLINE
020 8450 0515

or email helpline@timeguard.com

Qualified Customer Support Co-ordinators will be on-line
to assist in resolving your query.



Deta Electrical Co Ltd
Panattoni Park, Luton Road,
Chalton, Bedfordshire, LU4 9TT
Sales Office: 020 8452 1112
or email csc@timeguard.com

www.timeguard.com