

TIMEGUARD®

8.5W/17WLED Slimline Floodlight

- Model: LED100FLBP - Black (Single Flood)
- Model: LED100FLWHP - White (Single Flood)
- Model: LED200FLBP - Black (Twin Flood)
- Model: LED200FLWHP - White (Twin Flood)



Model: LED200FLWHP



Model: LED100FLWHP

Installation & Operating Instructions

1. General Information

These instructions should be read carefully and retained for further reference and maintenance.

Note: Timeguard reserve the right to alter these instructions at any time. Up to date instructions will always be available for download at www.timeguard.com

2. Safety

- Before installation or maintenance, ensure the mains supply to the luminaire is switched off and the circuit supply fuses are removed or the circuit breaker turned off.
- It is recommended that a qualified electrician is consulted or used for the installation of this luminaire and install in accordance with the current IEE wiring and Building Regulations.
- Check that the total load on the circuit including when this luminaire is fitted does not exceed the rating of the circuit cable, fuse or circuit breaker.
- To clean use a clean dry cloth only. Do not use liquid cleaners.

3. Technical Specifications

The specification below covers the single & twin head models.

- Mains Supply: 230V AC 50Hz
- This luminaire is of class II construction
- Energy Usage: 9 KwH/1000H (Single Head)
17 KwH/1000H (Twin Head)
- Beam Angle (Per Spotlight): 98° x 98°
- Lamp Adjustment Pan and Tilt: Left and Right 40°
,Downward 70°
- Lumen Output: 1000lm (Single Head)
2000lm (Twin Head)
- Colour Temperature: 4000K
- Operating Temperature: -20°C to +50°C

- Back Box Mounting Hole Centres: 60mm
- IP55 Rated, suitable for restricted external applications
- CE / UKCA Compliant
- Construction: Polycarbonate

Dimensions Single Head (H x W x D): 160mm x 80mm x 50mm

Twin Head (H x W x D): 160mm x 167mm x 50mm

4. Installation

- Ensure the mains supply is switched off and the circuit supply fuses are removed or the circuit breaker turned OFF (See image 1).
- An isolating switch should be installed to enable the power to be switched ON and OFF for maintenance purposes.

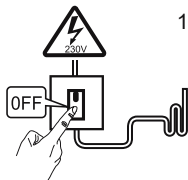

- Disconnect the back box from the luminaire by releasing the lugs (left or right side). See Image 2.

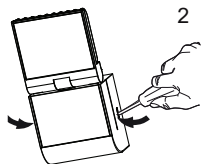

- Firmly grip the back box with your hand, from top and bottom and carefully pull away from the luminaire. See Image 3.

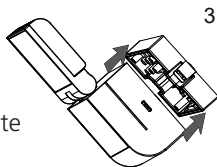

- Mark the position of the mounting holes on the wall using the back box as a template (See image 4). Drill the holes ensuring not to infringe with any gas/water pipes or electrical cables that may be hidden below the surface. Insert the rawl plugs into the holes. Pass the 230V 50Hz supply and load cables through the cable entry points on the back box, ensuring the grommets are used to maintain the IP rating of the luminaire.

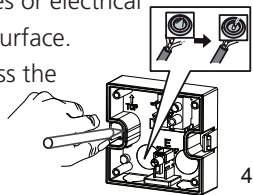

- Fix the back box to the wall using the 2 mounting screws, making sure it is the correct way up. Take care not to over-tighten the screws to prevent damage to the back box. If using a power screwdriver, use the lowest torque setting. See image 5.

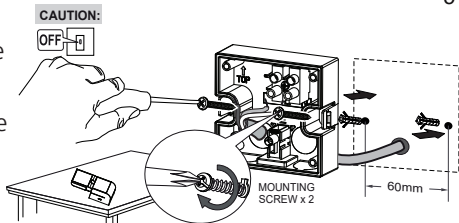

- Terminate the 230V 50Hz mains supply cable into the terminal block (See image 6)

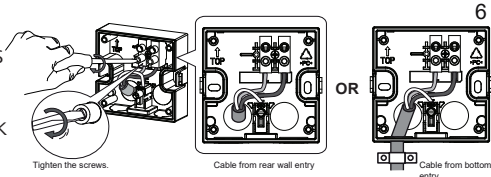

ensuring correct polarity is observed and that all bare conductors are sleeved (See section 5. Connection Diagram for wiring details).

- Re-connect the luminaire to the back box ensuring the 2 lugs firmly latch on the left and right hand side, indicated by a 'click'. See image 7.

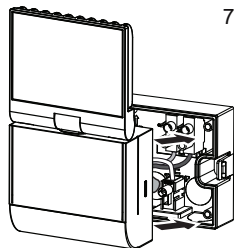

5. Connection Diagram

**230V AC 50Hz
MAINS SUPPLY**

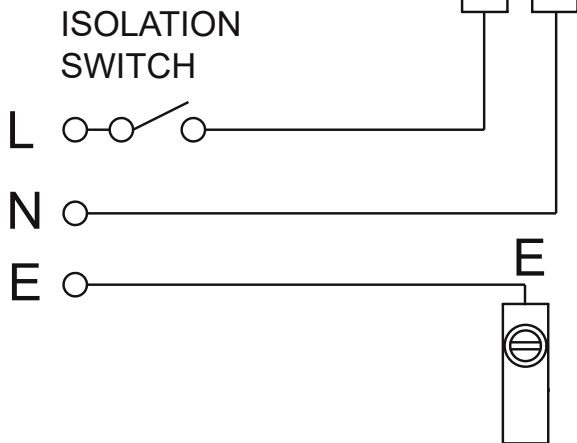

230V 50Hz Mains Supply

Live Supply (Brown or Red)

L

Neutral Supply (Blue or Black) to

N

Earth (Green/Yellow) to

E

Note terminal E is for earth continuity only.

6. Operation

- Turn the power on to the luminaire and test for normal operation. See image 8

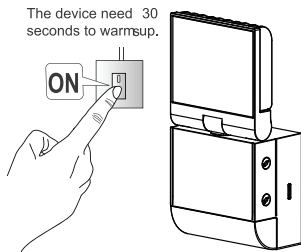

7. Lamp Adjustment

- Pan/Tilt adjustment options (Single Head).

Frontwards
Down 70°

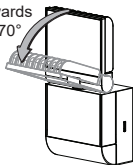

Backwards
Down 60°

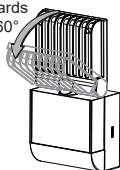

Left & Right 40° (limited by wall)

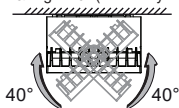

- Pan/Tilt adjustment options (Twin Head).

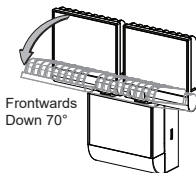

Pan Outward 21° (limited by wall)
Pan Inward 45°

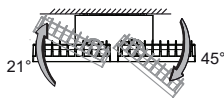

Pan Outward 45°, Pan Inward 45°
- with corner bracket

3 Year Guarantee

In the unlikely event of this product becoming faulty due to defective material or manufacture, within 3 years of the date of purchase, please return it to your supplier with proof of purchase and it will be replaced free of charge. For years 2 to 3 or with any difficulty in the first year, telephone our helpline. Note: a proof of purchase is required in all cases. For all eligible replacements (where agreed by Timeguard), the customer is responsible for all shipping/postage charges outside of the UK. All shipping costs are to be paid in advance before a replacement is sent.



If you experience problems, do not immediately return the unit to the store.

Email the Timeguard Customer Helpline:

HELPLINE

helpline@timeguard.com

or call the helpdesk on 020 8450 0515

Qualified Customer Support Coordinators will be online to assist in resolving your query.



Deta Electrical Co Ltd

Panattoni Park, Luton Road,
Chalton, Bedfordshire, LU4 9TT
Sales Office: 0208 452 1112
or email csc@timeguard.com

www.timeguard.com