

**TIMEGUARD®**

# IP68 Junction Box

Model: WXT68JB25



Installation & Operating Instructions

# Installation instructions



Isolate mains power supply before commencing.

If in doubt consult a qualified electrician.

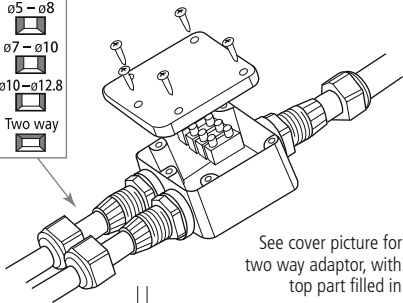
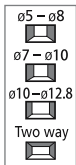

See cover picture for two way adaptor, with top part filled in.

1

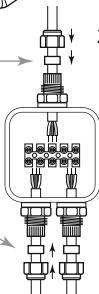
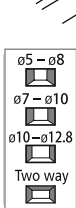

2.5Nm torque

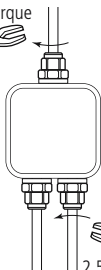

2.5Nm torque

## 3 Poles



## 5 Poles

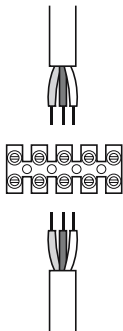

2

**Note:** When stripping the cables please use the measurements shown.

Min. cable diameter 5mm.  
Max. cable diameter 8mm.

### Ratings:

Current: 25A.

Voltage: 230V AC 50Hz.

Temperature: -20° to 85°C.

Dimensions: 138 x 72 x 40mm.

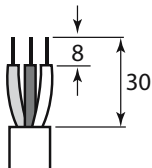

**Note:** Please observe the correct polarity when wiring.

## 3 Year Guarantee

In the unlikely event of this product becoming faulty due to defective material or manufacture within 3 years of the date of purchase, please return it to your supplier in the first year with proof of purchase and it will be replaced free of charge. For the second and third years or any difficulty in the first year telephone the helpline on 020 8450 0515.

Note: A proof of purchase is required in all cases. For all eligible replacements (where agreed by Timeguard) the customer is responsible for all shipping/postage charges outside of the UK. All shipping costs are to be paid in advance before a replacement is sent out.

For assistance with the product please contact:

HELPLINE **020 8450 0515**  
or email [helpline@timeguard.com](mailto:helpline@timeguard.com)



**Deta Electrical Co Ltd**  
Panattoni Park, Luton Road,  
Chalton, Bedfordshire, LU4 9TT  
Sales Office: 020 8452 1112  
or email [csc@timeguard.com](mailto:csc@timeguard.com)